

**RoHS Sxx65x & Sxx70x Series**

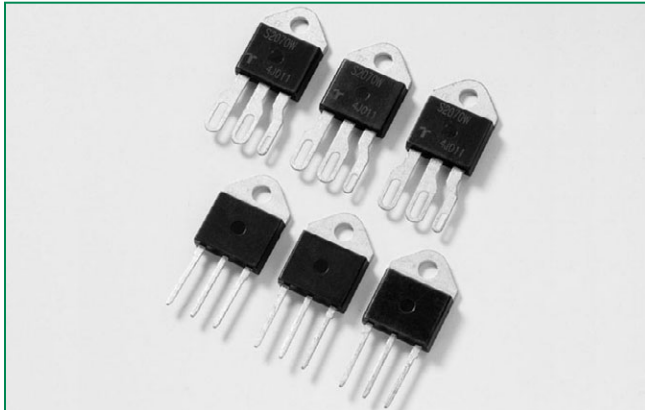

**Description**

Excellent unidirectional switches for phase control applications such as heating and motor speed controls. Standard phase control SCRs are triggered with few milliamperes of current at less than 1.5V potential.

**Features & Benefits**

- RoHS compliant
- Glass – passivated junctions
- Voltage capability up to 1000 V
- Surge capability up to 950 A

**Applications**

Typical applications are AC solid-state switches, industrial power tools, exercise equipment, white goods and commercial appliances.

Internally constructed isolated packages are offered for ease of heat sinking with highest isolation voltage.

**Agency Approval**

Agency	Agency File Number
	J & K Packages: E71639

**Main Features**

Symbol	Value	Unit
$I_{T(RMS)}$	65 & 70	A
$V_{DRM}/V_{RRM}$	400 to 1000	V
$I_{GT}$	50	mA

**Schematic Symbol**

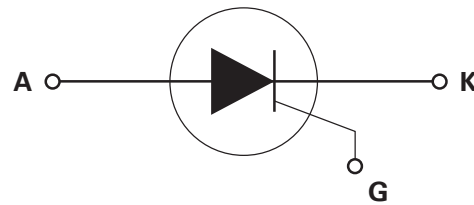

**Absolute Maximum Ratings**

Symbol	Parameter	Test Conditions		Value	Unit
		Part Number	Temperature		
$I_{T(RMS)}$	RMS on-state current	Sxx65J Sxx65K	$T_c = 75^\circ C$	65	A
		Sxx70W	$T_c = 80^\circ C$	70	
$I_{T(AV)}$	Average on-state current	Sxx65J Sxx65K	$T_c = 75^\circ C$	41.0	A
		Sxx70W	$T_c = 80^\circ C$	45.0	
$I_{TSM}$	Peak non-repetitive surge current	single half cycle; $f = 50\text{Hz}$ ; $T_j$ (initial) = $25^\circ C$		800	A
		single half cycle; $f = 60\text{Hz}$ ; $T_j$ (initial) = $25^\circ C$		950	
$I^2t$	$I^2t$ Value for fusing	$t_p = 8.3\text{ms}$		3745	$A^2s$
$di/dt$	Critical rate of rise of on-state current	$f = 60\text{Hz}$ ; $T_j = 125^\circ C$		200	$A/\mu s$
$I_{GM}$	Peak gate current	$T_j = 125^\circ C$ $P_w = \mu S$		5.0	A
$P_{G(AV)}$	Average gate power dissipation	$T_j = 125^\circ C$		1.0	W
$T_{stg}$	Storage temperature range			-40 to 150	$^\circ C$
$T_j$	Operating junction temperature range			-40 to 125	$^\circ C$

65/70 A SCRs

**Electrical Characteristics ( $T_J = 25^\circ\text{C}$ , unless otherwise specified)**

Symbol	Test Conditions		Value	Unit	
$I_{GT}$	$V_D = 12\text{V}; R_L = 30\ \Omega$		MAX.	50	mA
			MIN.	5	
$V_{GT}$			MAX.	2.0	V
dv/dt	$V_D = V_{DRM}; \text{gate open}; T_J = 100^\circ\text{C}$	400V	MIN.	650	V/ $\mu\text{s}$
		600V		600	
		800V		500	
	$V_D = V_{DRM}; \text{gate open}; T_J = 125^\circ\text{C}$	400V		250	
		600V		550	
		800V		500	
$V_{GD}$	$V_D = V_{DRM}; R_L = 3.3\ \text{k}\Omega; T_J = 125^\circ\text{C}$		MIN.	0.2	V
$I_H$	$I_T = 400\text{mA (initial)}$		MAX.	80	mA
$t_q$	(1)		MAX.	35	$\mu\text{s}$
$t_{gt}$	$I_G = 2 \times I_{GT}; \text{PW} = 15\mu\text{s}; I_T = 140\text{A}$		TYP.	2.5	$\mu\text{s}$

Note :  
(1)  $I_T=2\text{A}; t_p=50\mu\text{s}; dv/dt=5\text{V}/\mu\text{s}; di/dt=30\text{A}/\mu\text{s}$

**Static Characteristics**

Symbol	Test Conditions		Value	Unit	
$V_{TM}$	65A Device $I_T = 130\text{A}; t_p = 380\mu\text{s}$		MAX.	1.8	V
	70A Device $I_T = 140\text{A}; t_p = 380\mu\text{s}$				
$I_{DRM} / I_{RRM}$	$V_{DRM} / V_{RRM}$	$T_J = 25^\circ\text{C}$	MAX.	400 – 800V	20
				1000 V	30
		$T_J = 100^\circ\text{C}$		400 – 600V	1500
				800V	2000
				1000V	5000
		$T_J = 125^\circ\text{C}$		400V – 600V	3000
800V	5000				

**Thermal Resistances**

Symbol	Parameter	Value	Unit	
$R_{\theta(J-C)}$	Junction to case (AC)	Sxx65J Sxx65K	0.86	$^\circ\text{C}/\text{W}$
		Sxx70W	0.6	

Note: xx = voltage

**Figure 1: Normalized DC Gate Trigger Current vs. Junction Temperature**

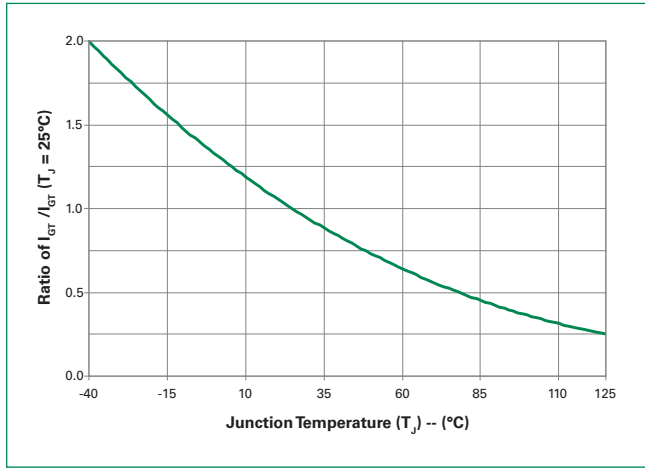

**Figure 2: Normalized DC Gate Trigger Voltage vs. Junction Temperature**

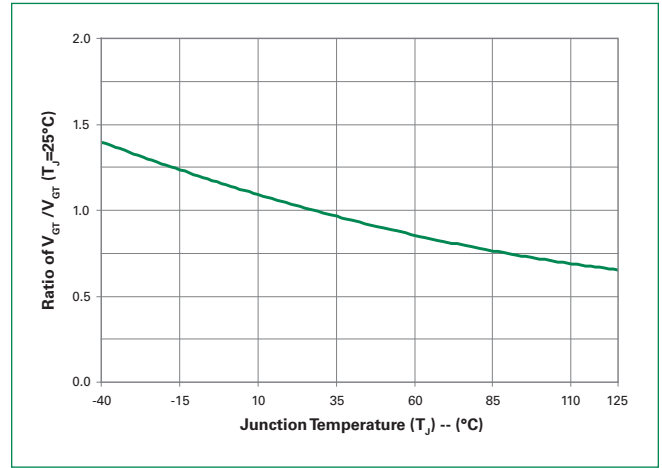

**Figure 3: Normalized DC Holding Current vs. Junction Temperature**

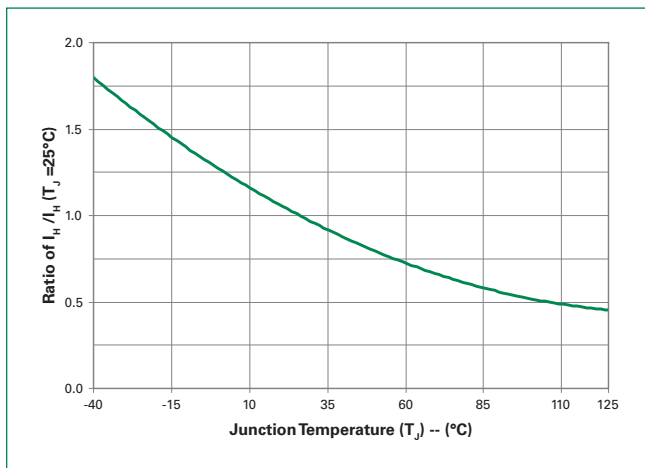

**Figure 4: On-State Current vs. On-State Voltage (Typical)**

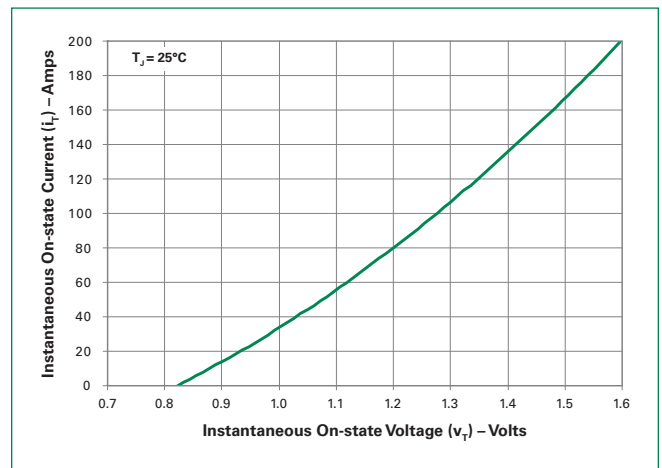

**Figure 5: Power Dissipation (Typical) vs. RMS On-State Current**

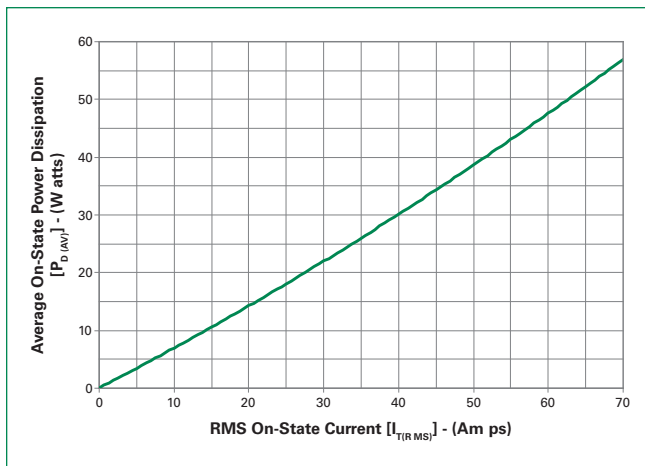

**Figure 6: Maximum Allowable Case Temperature vs. RMS On-State Current**

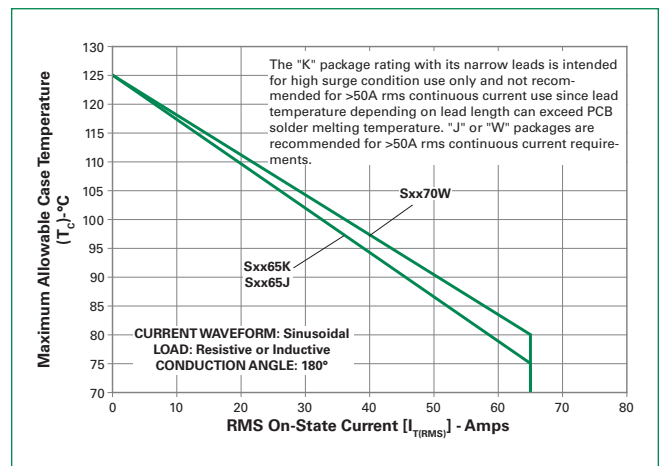

Note: xx = voltage

Figure 7: Maximum Allowable Case Temperature vs. Average On-State Current

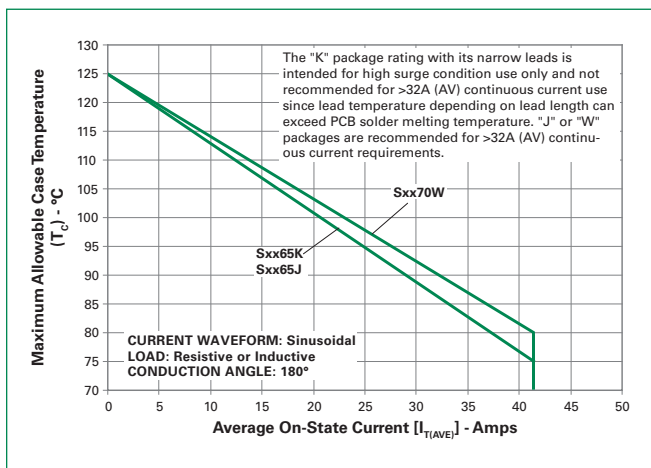

Figure 8: Peak Capacitor Discharge Current

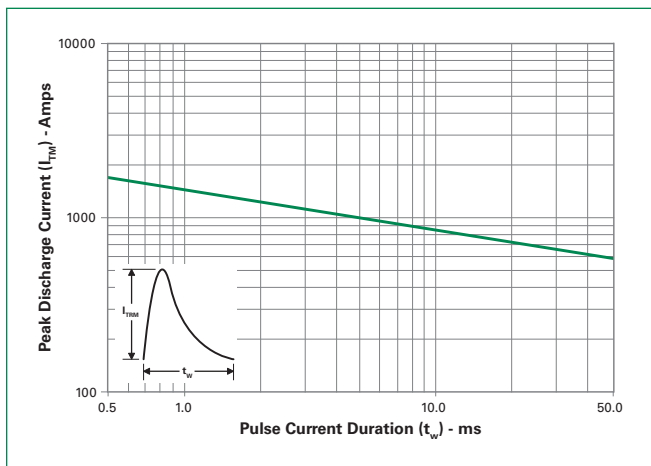

Figure 9: Peak Capacitor Discharge Current Derating

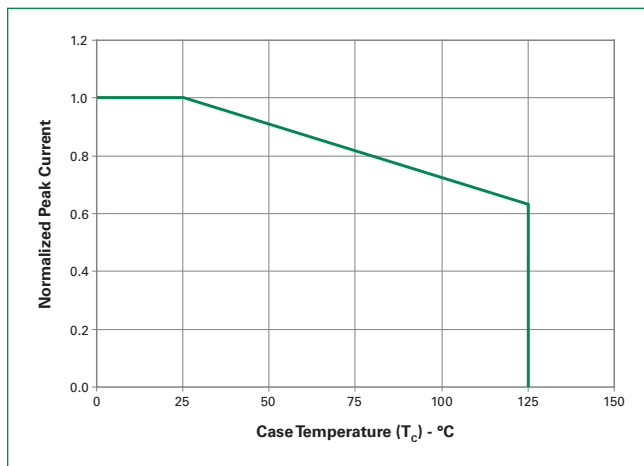
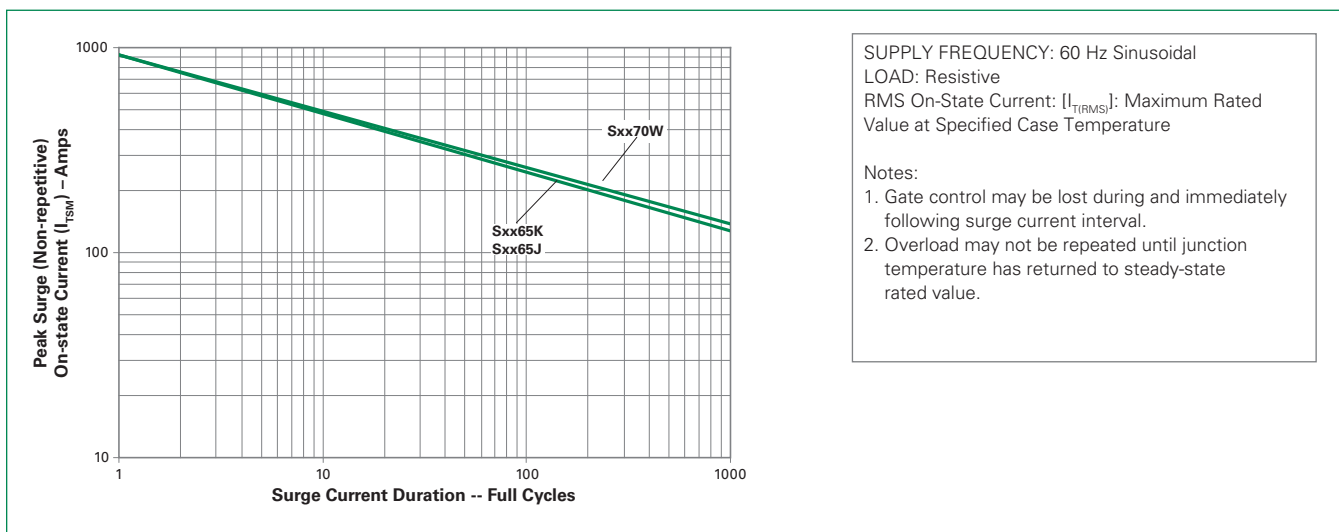

Figure 10: Surge Peak On-State Current vs. Number of Cycles



Note: xx = Voltage

### Soldering Parameters

Reflow Condition		Pb – Free assembly
Pre Heat	- Temperature Min ( $T_{s(min)}$ )	150°C
	- Temperature Max ( $T_{s(max)}$ )	200°C
	- Time (min to max) ( $t_s$ )	60 – 180 secs
Average ramp up rate (Liquidus Temp ( $T_L$ ) to peak)		5°C/second max
$T_{s(max)}$ to $T_L$ - Ramp-up Rate		5°C/second max
Reflow	- Temperature ( $T_L$ ) (Liquidus)	217°C
	- Temperature ( $t_L$ )	60 – 150 seconds
Peak Temperature ( $T_p$ )		260 <sup>+0/-5</sup> °C
Time within 5°C of actual peak Temperature ( $t_p$ )		20 – 40 seconds
Ramp-down Rate		5°C/second max
Time 25°C to peak Temperature ( $T_p$ )		8 minutes Max.
Do not exceed		280°C

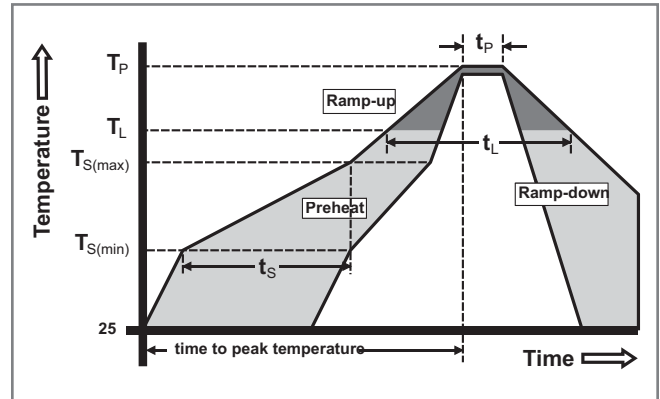

### Physical Specifications

<b>Terminal Finish</b>	100% Matte Tin-plated
<b>Body</b>	UL recognized epoxy meeting flammability classification 94V-0
<b>Lead Material</b>	Copper Alloy

### Design Considerations

Careful selection of the correct device for the application's operating parameters and environment will go a long way toward extending the operating life of the Thyristor. Good design practice should limit the maximum continuous current through the main terminals to 75% of the device rating. Other ways to ensure long life for a power discrete semiconductor are proper heat sinking and selection of voltage ratings for worst case conditions. Overheating, overvoltage (including dv/dt), and surge currents are the main killers of semiconductors. Correct mounting, soldering, and forming of the leads also help protect against component damage.

### Environmental Specifications

Test	Specifications and Conditions
<b>AC Blocking</b>	MIL-STD-750, M-1040, Cond A Applied Peak AC voltage @ 125°C for 1008 hours
<b>Temperature Cycling</b>	MIL-STD-750, M-1051, 100 cycles; -40°C to +150°C; 15-min dwell-time
<b>Temperature/Humidity</b>	EIA / JEDEC, JESD22-A101 1008 hours; 320V - DC; 85°C; 85% rel humidity
<b>High Temp Storage</b>	MIL-STD-750, M-1031, 1008 hours; 150°C
<b>Low-Temp Storage</b>	1008 hours; -40°C
<b>Thermal Shock</b>	MIL-STD-750, M-1056 10 cycles; 0°C to 100°C; 5-min dwelltime at each temperature; 10 sec (max) transfer time between temperature
<b>Autoclave</b>	EIA / JEDEC, JESD22-A102 168 hours (121°C at 2 ATMs) and 100% R/H
<b>Resistance to Solder Heat</b>	MIL-STD-750 Method 2031
<b>Solderability</b>	ANSI/J-STD-002, category 3, Test A
<b>Lead Bend</b>	MIL-STD-750, M-2036 Cond E

**Dimensions –TO-218X (W Package) – Non-Isolated Mounting Tab**

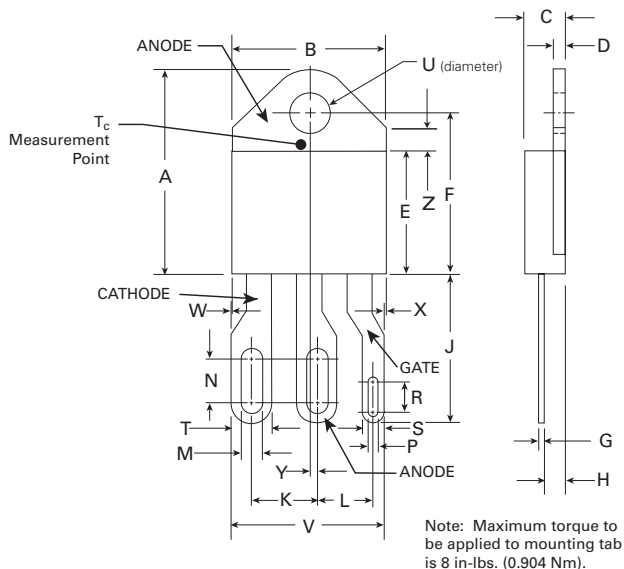

Dimension	Inches		Millimeters	
	Min	Max	Min	Max
A	0.810	0.835	20.57	21.21
B	0.610	0.630	15.49	16.00
C	0.178	0.188	4.52	4.78
D	0.055	0.070	1.40	1.78
E	0.487	0.497	12.37	12.62
F	0.635	0.655	16.13	16.64
G	0.022	0.029	0.56	0.74
H	0.075	0.095	1.91	2.41
J	0.575	0.625	14.61	15.88
K	0.256	0.264	6.50	6.71
L	0.220	0.228	5.58	5.79
M	0.080	0.088	2.03	2.24
N	0.169	0.177	4.29	4.49
P	0.034	0.042	0.86	1.07
R	0.113	0.121	2.87	3.07
S	0.086	0.096	2.18	2.44
T	0.156	0.166	3.96	4.22
U	0.164	0.165	4.10	4.20
V	0.603	0.618	15.31	15.70
W	0.000	0.005	0.00	0.13
X	0.003	0.012	0.07	0.30
Y	0.028	0.032	0.71	0.81
Z	0.085	0.095	2.17	2.42

**Dimensions –TO-218AC (K Package) – Isolated Mounting Tab**

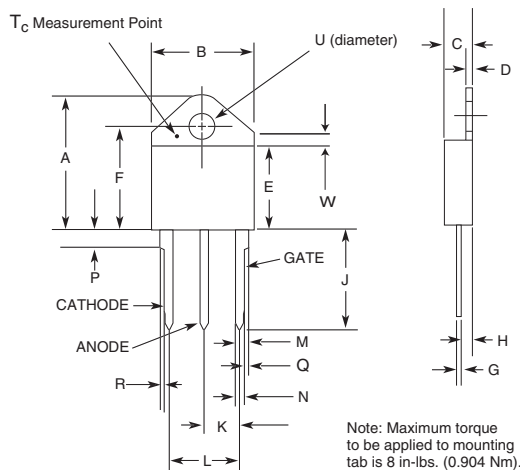

Dimension	Inches		Millimeters	
	Min	Max	Min	Max
A	0.810	0.835	20.57	21.21
B	0.610	0.630	15.49	16.00
C	0.178	0.188	4.52	4.78
D	0.055	0.070	1.40	1.78
E	0.487	0.497	12.37	12.62
F	0.635	0.655	16.13	16.64
G	0.022	0.029	0.56	0.74
H	0.075	0.095	1.91	2.41
J	0.575	0.625	14.61	15.88
K	0.211	0.219	5.36	5.56
L	0.422	0.437	10.72	11.10
M	0.058	0.068	1.47	1.73
N	0.045	0.055	1.14	1.40
P	0.095	0.115	2.41	2.92
Q	0.008	0.016	0.20	0.41
R	0.008	0.016	0.20	0.41
U	0.164	0.165	4.10	4.20
W	0.085	0.095	2.17	2.42

**Dimensions – TO-218X (J Package) — Isolated Mounting Tab Common with Center Lead**

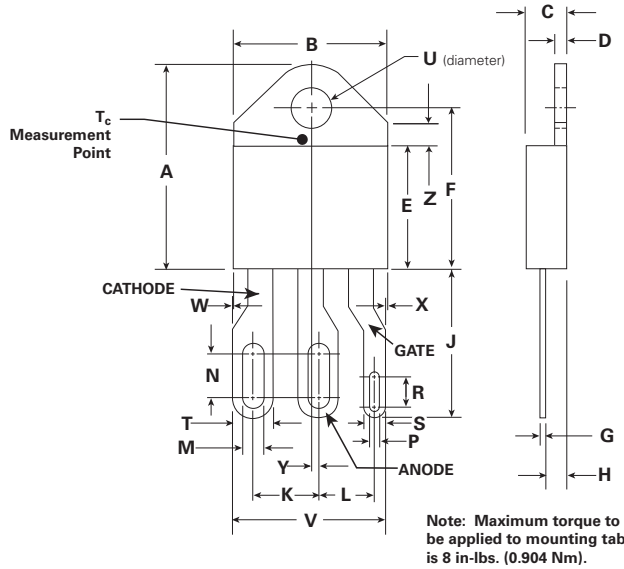

Dimension	Inches		Millimeters	
	Min	Max	Min	Max
A	0.810	0.835	20.57	21.21
B	0.610	0.630	15.49	16.00
C	0.178	0.188	4.52	4.78
D	0.055	0.070	1.40	1.78
E	0.487	0.497	12.37	12.62
F	0.635	0.655	16.13	16.64
G	0.022	0.029	0.56	0.74
H	0.075	0.095	1.91	2.41
J	0.575	0.625	14.61	15.88
K	0.256	0.264	6.50	6.71
L	0.220	0.228	5.58	5.79
M	0.080	0.088	2.03	2.24
N	0.169	0.177	4.29	4.49
P	0.034	0.042	0.86	1.07
R	0.113	0.121	2.87	3.07
S	0.086	0.096	2.18	2.44
T	0.156	0.166	3.96	4.22
U	0.164	0.165	4.10	4.20
V	0.603	0.618	15.31	15.70
W	0.000	0.005	0.00	0.13
X	0.003	0.012	0.07	0.30
Y	0.028	0.032	0.71	0.81
Z	0.085	0.095	2.17	2.42

**Product Selector**

Part Number	Voltage				Gate Sensitivity	Type	Package
	400V	600V	800V	1000V			
Sxx65K	X	X	X	X	50mA	Standard SCR	TO-218AC
Sxx65J	X	X	X		50mA	Standard SCR	TO-218X
Sxx70W	X	X	X		50mA	Standard SCR	TO-218X

Note: xx = Voltage

**Packing Options**

Part Number	Marking	Weight	Packing Mode	Base Quantity
Sxx65KTP	Sxx65K	4.40g	Tube	250 (25 per tube)
Sxx65JTP	Sxx65J	5.23g	Tube	250 (25 per tube)
Sxx70WTP	Sxx70W	5.23g	Tube	250 (25 per tube)

Note: xx = Voltage

65/70 A SCRs

**Part Numbering System**

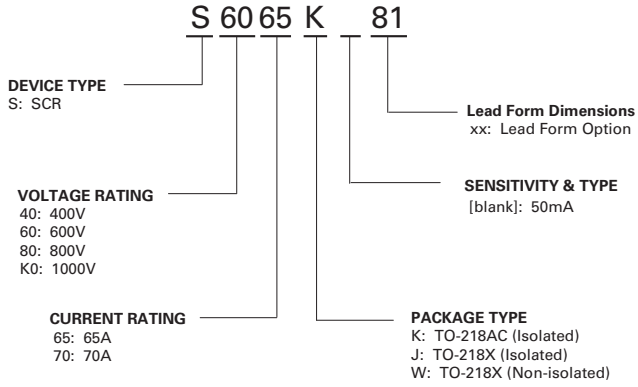

**Part Marking System**

- TO-218AC - (K Package)
- TO-218X - (J Package)
- TO-218X - (W Package)

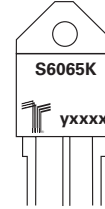



# Mouser Electronics

Authorized Distributor

Click to View Pricing, Inventory, Delivery & Lifecycle Information:

## Littelfuse:

[S4065K](#) [S6065KTP](#) [S4070W](#) [S6070W](#) [S8065J](#) [SK065K](#) [S8070W](#) [S2070W82](#) [SK065KTP](#) [S6070WTP](#) [S6065JTP](#)  
[S4070WTP](#) [S4065KTP](#) [S4065JTP](#) [S8065JTP](#) [S8065KTP](#) [S8070WTP](#)